



Cambridge IGCSE™

CANDIDATE
NAME

--

CENTRE
NUMBER

--	--	--	--	--

CANDIDATE
NUMBER

--	--	--	--



MATHEMATICS

0580/32

Paper 3 (Core)

May/June 2022

2 hours

You must answer on the question paper.

You will need: Geometrical instruments

INSTRUCTIONS

- Answer **all** questions.
- Use a black or dark blue pen. You may use an HB pencil for any diagrams or graphs.
- Write your name, centre number and candidate number in the boxes at the top of the page.
- Write your answer to each question in the space provided.
- Do **not** use an erasable pen or correction fluid.
- Do **not** write on any bar codes.
- You should use a calculator where appropriate.
- You may use tracing paper.
- You must show all necessary working clearly.
- Give non-exact numerical answers correct to 3 significant figures, or 1 decimal place for angles in degrees, unless a different level of accuracy is specified in the question.
- For π , use either your calculator value or 3.142.

INFORMATION

- The total mark for this paper is 104.
- The number of marks for each question or part question is shown in brackets [].

This document has **20** pages. Any blank pages are indicated.

1 Antonio has a shop near the beach.

(a) (i) He makes a tally of the number of ice creams he sells on Friday.

|||| ||| ||| ||| ||| ||| ||| ||| ||| ||| |||

Work out the number of ice creams he sells on Friday.

..... [1]

(ii) 15 of the ice creams he sells on Friday are vanilla.

Work out the fraction of ice creams he sells on Friday that are vanilla.
Give your answer in its simplest form.

..... [1]

(iii) He buys tubs of ice cream for his shop in the ratio vanilla : chocolate = 11 : 7.
He buys 28 tubs of chocolate ice cream.

Work out how many tubs of vanilla ice cream he buys.

..... [2]

(b) Antonio records the number of chairs his shop hires out on each day for a week.

123 98 116 45 67 165 156

(i) Work out the range.

..... [1]

(ii) Find the median.

..... [2]

(iii) Calculate the mean.

..... [2]

- (c) (i) Antonio buys beach balls for \$2.50 each and sells them for \$4.20 each.

Work out the percentage profit he makes on each beach ball.

..... % [2]

- (ii) A beach ball is a sphere with radius 15 cm.

Calculate the volume of the beach ball.
Give the units of your answer.

[The volume, V , of a sphere with radius r is $V = \frac{4}{3}\pi r^3$.]

..... [3]

- (d) The shop sells sun cream in bottles A , B and C .



Work out which bottle is the best value.
You must show all your working.

Bottle [3]

2 (a) (i) Complete the table of values for $y = \frac{-6}{x}$.

x	-6	-4	-3	-2	-1.5	-1		1	1.5	2	3	5	6
y	1		2	3		6		-6		-3	-2		-1

[3]

(ii) On the grid, draw the graph of $y = \frac{-6}{x}$ for $-6 \leq x \leq -1$ and $1 \leq x \leq 6$.

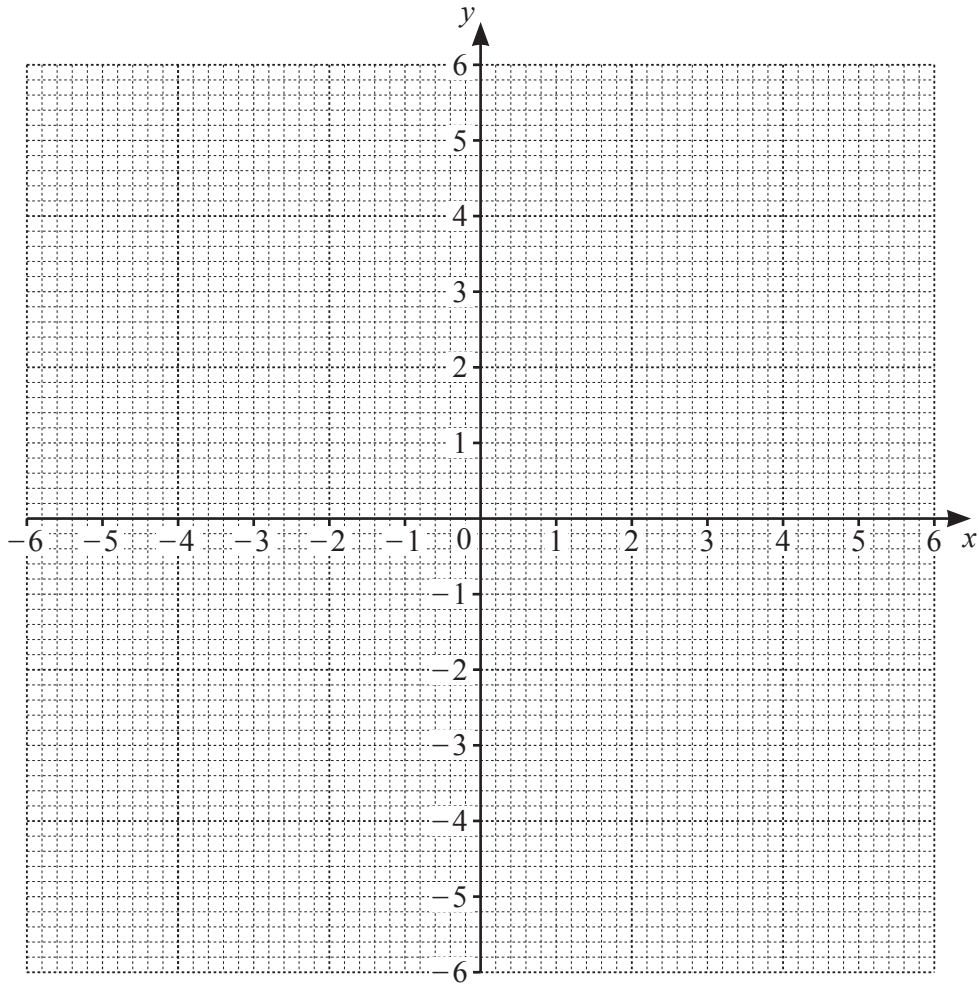

[4]

(iii) Write down the order of rotational symmetry of the graph.

..... [1]

(iv) Write down the equation of each line of symmetry of the graph.

..... and [2]

(v) On the grid, draw the line $y = 2.5$. [1]

(vi) Use your graph to solve the equation $\frac{-6}{x} = 2.5$.

$x = \dots\dots\dots$ [1]

(b)

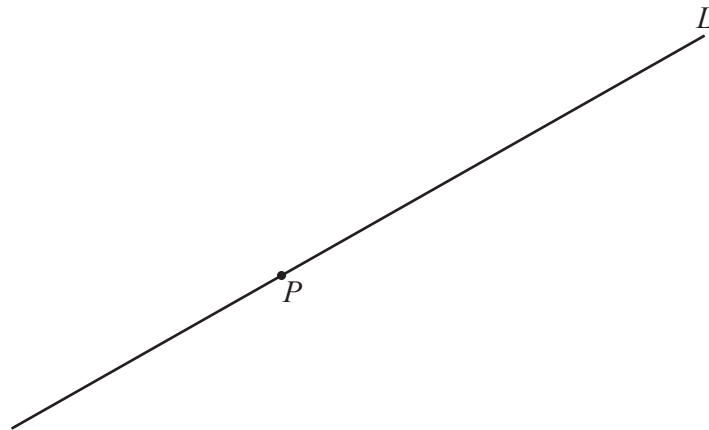

Draw a line that passes through the point P and is perpendicular to line L . [1]

(c) Find the equation of the straight line that

- is parallel to the line $y = 3x + 5$
- and
- passes through the point $(1, 7)$.

Give your answer in the form $y = mx + c$.

$y = \dots\dots\dots$ [2]

3 (a)

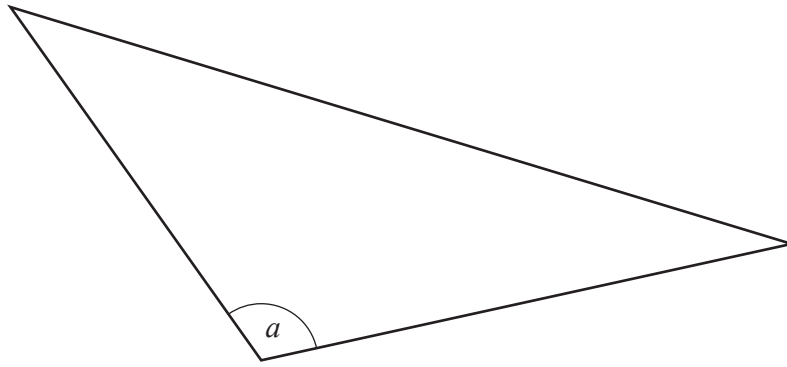

(i) Write down the mathematical name for the type of angle a .

..... [1]

(ii) Measure angle a .

..... [1]

(b) Kate describes a quadrilateral.

- All the sides are the same length.
- It has only two lines of symmetry.

(i) Draw a sketch of this quadrilateral.

[1]

(ii) Write down the mathematical name for this quadrilateral.

..... [1]

(iii) One of the interior angles of this quadrilateral is 70° .

Work out the other three interior angles.

.....,, [2]

- (c) The diagrams show the angles in a triangle and two angles on a straight line.

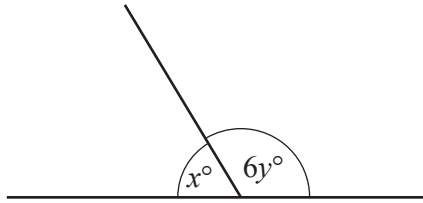
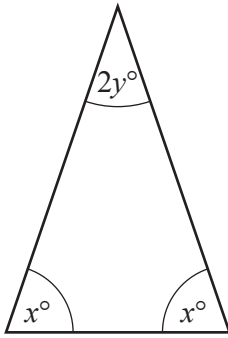

NOT TO
SCALE

- (i) The triangle is used to write down an equation in terms of x and y .

$$2x + 2y = 180$$

Give the geometrical reason why this equation is correct.

Reason [1]

- (ii) Use the diagram with two angles on a straight line to write down another equation in terms of x and y .

..... [1]

- (iii) Solve these simultaneous equations.
You must show all your working.

$$x = \dots\dots\dots$$

$$y = \dots\dots\dots [3]$$

- 4 (a) The diagram shows the net of a cuboid.

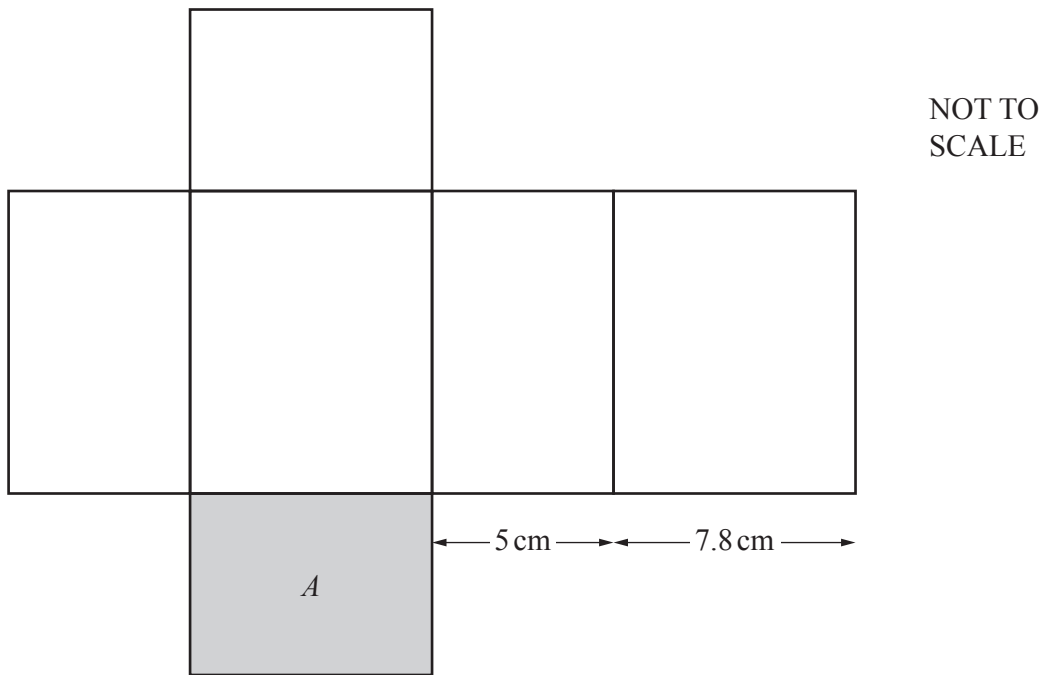

- (i) Work out the area of the shaded rectangle, A .

..... cm^2 [2]

- (ii) The volume of the cuboid is 468 cm^3 .

Complete the statement.

The dimensions of the cuboid are cm by cm by cm [2]

(b) A cylinder has a radius of 8 cm and a height of 12 cm.

Calculate, in terms of π , the volume of the cylinder.

..... cm^3 [2]

(c)

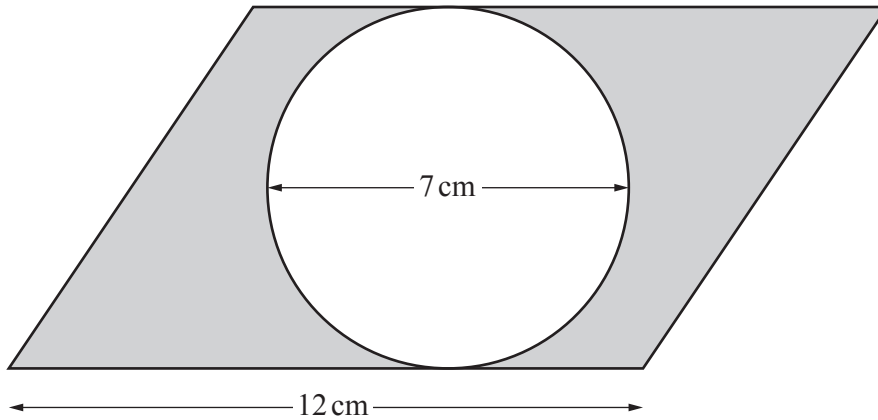

NOT TO
SCALE

The diagram shows a circle with a diameter of 7 cm and a parallelogram with a base of 12 cm. The circle touches two of the sides of the parallelogram.

Calculate the shaded area.

..... cm^2 [3]

5 Rebecca records the flight distance and the ticket price for each of her last 12 plane journeys.

Flight distance (km)	95	230	70	500	200	450	600	350	100	275	380	540
Ticket price (\$)	220	210	60	380	130	270	340	250	120	170	310	305

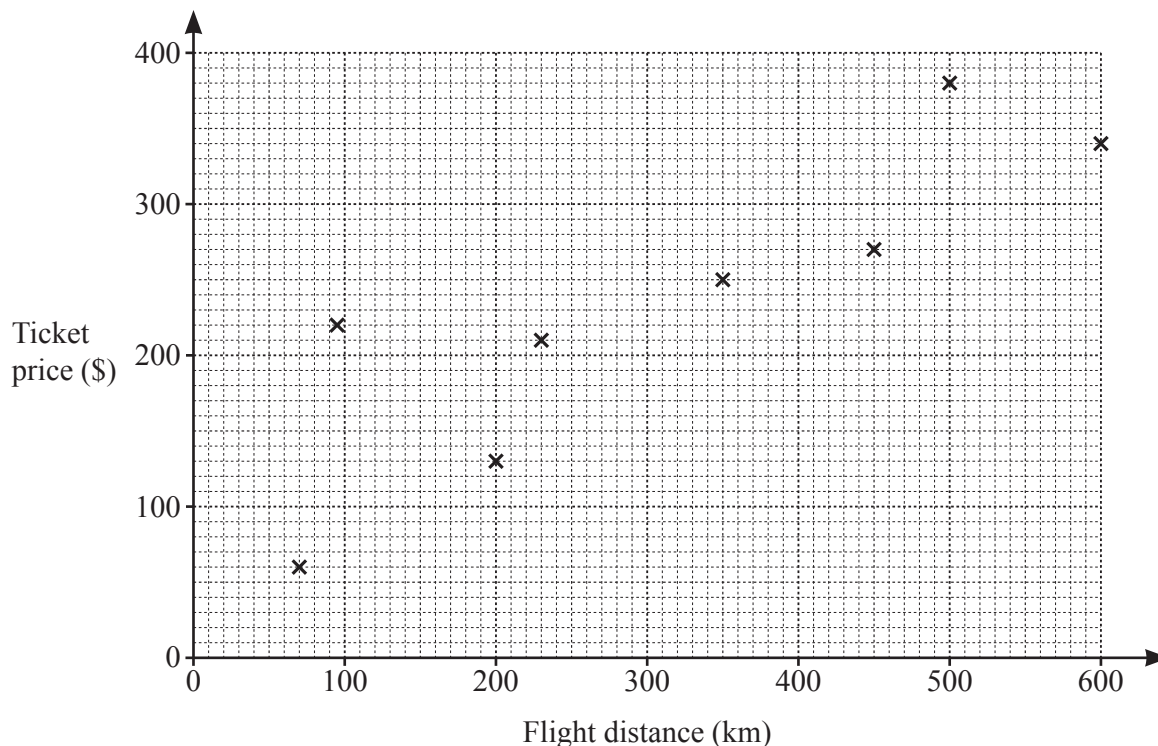

- (a) Complete the scatter diagram.
The first eight points have been plotted for you. [2]

- (b) What type of correlation is shown in the scatter diagram?
..... [1]

- (c) On the scatter diagram, put a ring around the point for the journey that has the highest price per kilometre travelled. [1]

- (d) On the scatter diagram, draw a line of best fit. [1]

- (e) The scale drawing shows two airports, K and L .
The scale is 1 centimetre represents 50 kilometres.

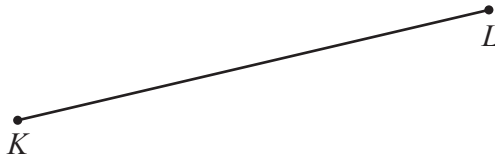

Scale: 1 cm to 50 km

A plane flies in a straight line from K to L .

Use the scale drawing and your line of best fit to find an estimate for the ticket price of the journey from K to L .

\$ [3]

6 Mr Vay works in a bank.

(a) The travel graph shows Mr Vay’s journey from his home to the bank.

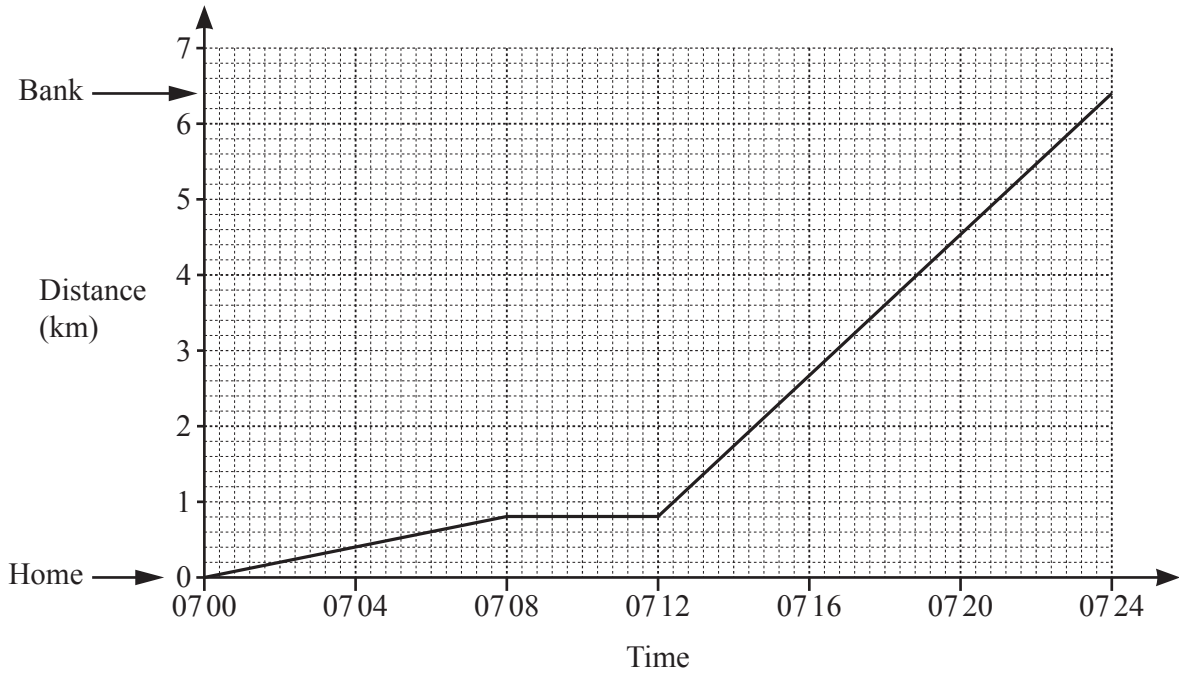

(i) Write down the distance Mr Vay travels in the first 8 minutes.

..... km [1]

(ii) Explain what is happening between 0708 and 0712.

..... [1]

(iii) Between which times is Mr Vay’s journey the fastest?
Give a reason for your answer.

Between and

Reason [2]

(iv) Work out Mr Vay’s average speed for the whole journey.
Give your answer in kilometres per hour.

..... km/h [3]

- (b) Katya takes some coins to the bank.
The table shows the number of each type of coin.

Type of coin	Number of coins
1 cent	12
5 cent	23
10 cent	17
25 cent	9
50 cent	7
1 dollar	24

Work out the total amount of money Katya takes to the bank.
Give your answer in dollars.

\$ [2]

- (c) Adam changes \$700 into euros at the bank.
The exchange rate is \$1 = 0.904 euros.

Work out the amount Adam receives.

..... euros [1]

- (d) Clara invests \$8500 for 4 years at a rate of 1.7% per year simple interest.

Calculate the total interest earned during the 4 years.

\$ [2]

7 (a)

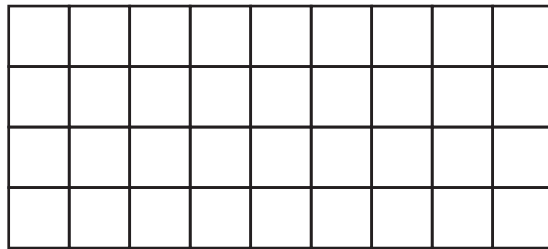
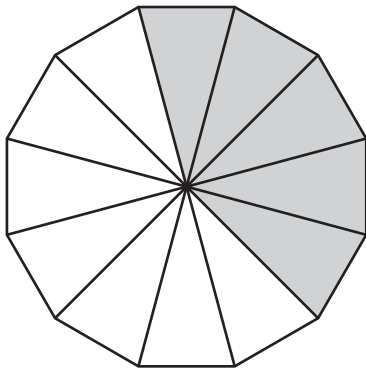

Shade some squares so that both shapes have the same fraction shaded. [2]

(b) Here is a pattern.



Position number 1 is a .

Position number 2 is a .

(i) Draw the next two shapes in this pattern. [1]

(ii) What do the position numbers of the shape have in common?
 [1]

(iii) Pierre says that the shape in position number 99 is a .

Explain why he is correct.

.....
 [2]

(c) $\mathcal{U} = \{ \bullet, \circ, \blacktriangle, \triangle, \blacksquare, \square, \blacksquare, \square \}$

This universal set has twelve elements.

Each shape is:

- a circle, C , or a triangle, T , or a rectangle, R
- large, L , or small, S
- black, B , or white, W .

(i)

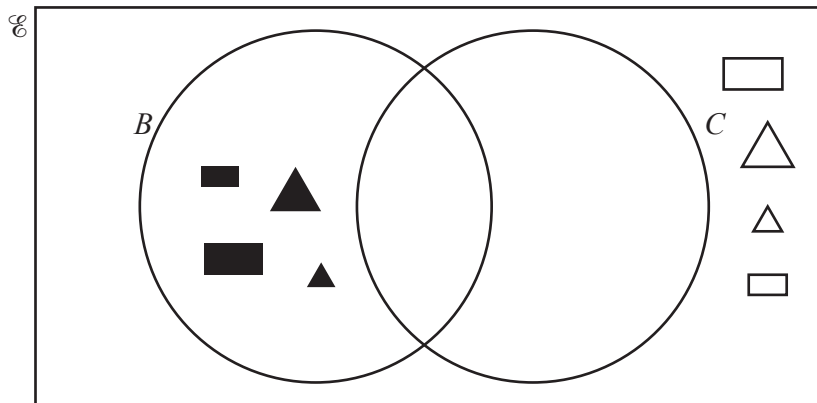

The triangles and rectangles are drawn in the Venn diagram.

(a) Draw the four circles to complete the Venn diagram. [1]

(b) Find $n(B \cup C)$.
 [1]

(ii) Six of the twelve shapes are drawn in another Venn diagram.

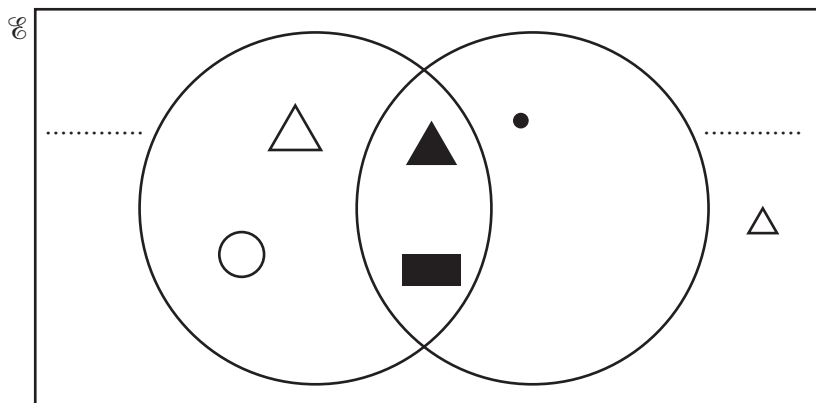

Complete the Venn diagram by:

- labelling the sets
- and
- drawing the shapes $\bullet, \circ, \blacktriangle, \square, \blacksquare$ and \square .
- [3]

8 (a) (i) Show that the exterior angle of a regular octagon is 45° .

[1]

(ii) Find the interior angle of a regular octagon.

..... [1]

(b)

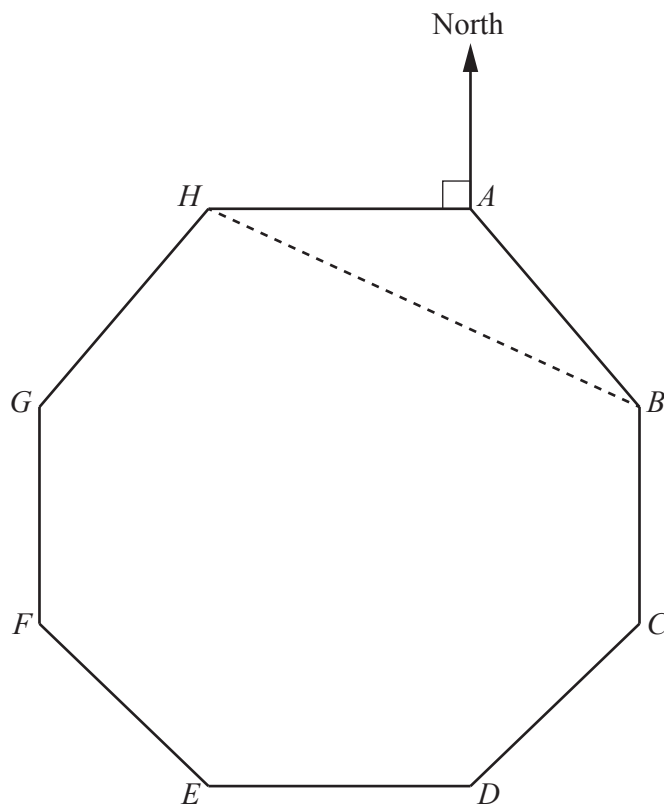

NOT TO SCALE

The diagram shows the route of a boat race.
The route is in the shape of a regular octagon, $ABCDEFGH$.
 H is due west of A .

(i) Find the bearing of B from A .

..... [1]

(ii) Complete this statement.

The bearing of C from D is the same as the bearing of from [1]

(iii) (a) Write down the mathematical name of triangle ABH .

..... [1]

(b) Calculate angle ABH .

Angle $ABH =$ [2]

(c) Work out the bearing of H from B .

..... [2]

(c) Each side of the octagon is 1.35 km.
The average speed of a boat is 45 km/h.

Work out the time it will take this boat to complete the race.
Give your answer in minutes.

..... min [3]

(d) Hetty wants to draw a scale drawing of the route.
She chooses a scale of 1:500 000.

Has Hetty chosen a suitable scale?
Show all your working and explain your decision.

..... because [2]

9 The grid shows three shapes, *A*, *B* and *C*.

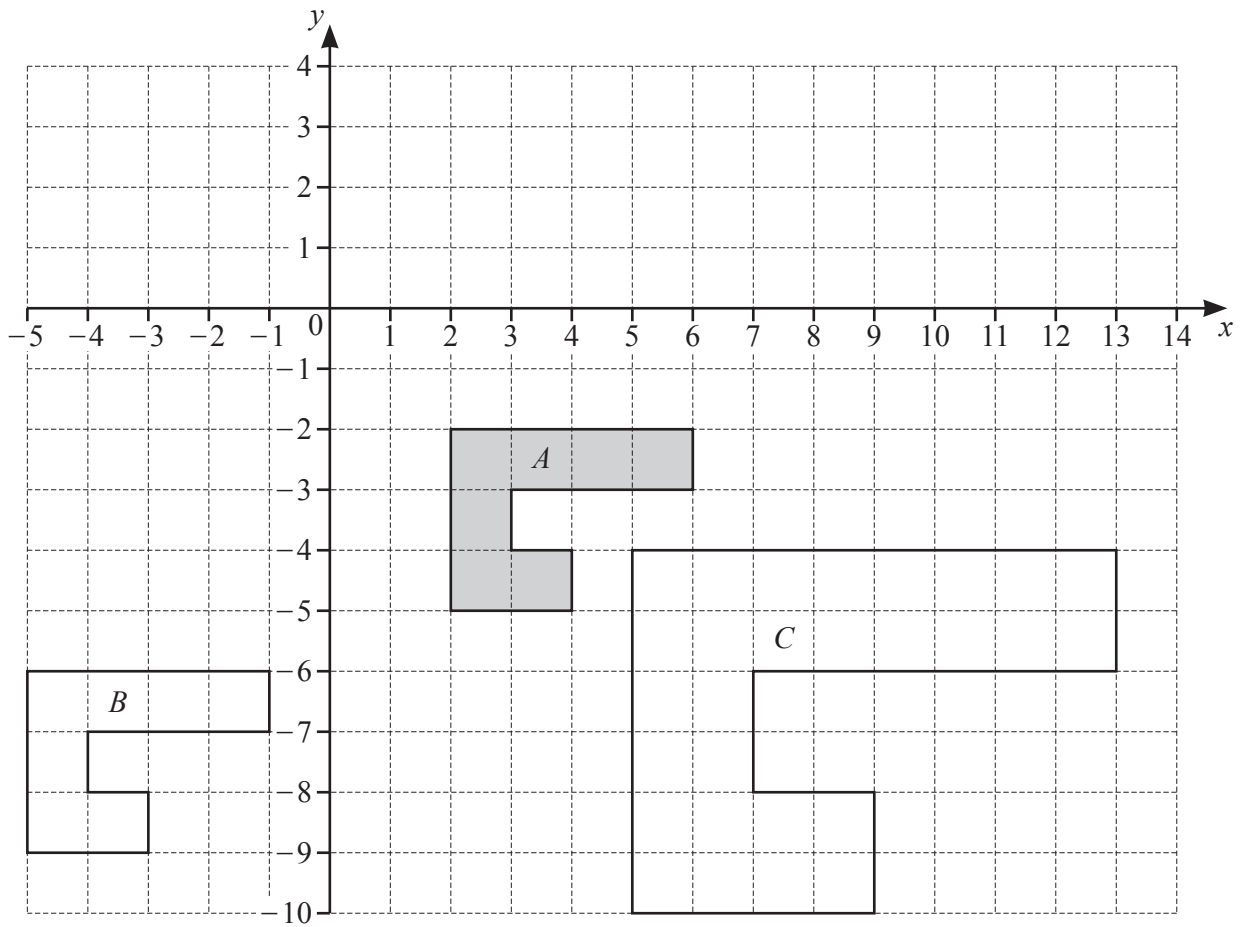

(a) Describe fully the **single** transformation that maps

(i) shape *A* onto shape *B*,

.....
 [2]

(ii) shape *A* onto shape *C*.

.....
 [3]

(b) On the grid, draw the image of shape *A* after a rotation, 90° clockwise, centre $(6, -3)$. [2]

BLANK PAGE

Permission to reproduce items where third-party owned material protected by copyright is included has been sought and cleared where possible. Every reasonable effort has been made by the publisher (UCLES) to trace copyright holders, but if any items requiring clearance have unwittingly been included, the publisher will be pleased to make amends at the earliest possible opportunity.

To avoid the issue of disclosure of answer-related information to candidates, all copyright acknowledgements are reproduced online in the Cambridge Assessment International Education Copyright Acknowledgements Booklet. This is produced for each series of examinations and is freely available to download at www.cambridgeinternational.org after the live examination series.

Cambridge Assessment International Education is part of Cambridge Assessment. Cambridge Assessment is the brand name of the University of Cambridge Local Examinations Syndicate (UCLES), which is a department of the University of Cambridge.