

Answer **all** the questions.

- 1 A grain of salt weighs 6.48×10^{-5} kg on average.
A packet contains 0.35 kg of salt.

(a) Use this information to calculate the number of grains of salt in the packet.

$$\frac{0.35}{6.48 \times 10^{-5}} =$$

(a)5401..... [2]

(b) Explain why your answer to part (a) is unlikely to be the actual number of grains of salt in the packet.

.....The weight on the packet is unlikely to
.....be exactly correct.....
..... [1]

- 3 (a) This spinner has two grey sections, two white sections and one black section.

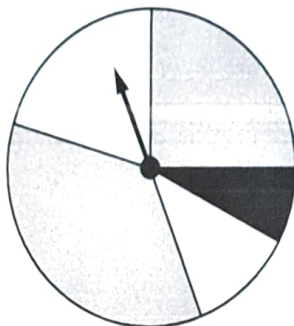

Vlad says

The probability of the spinner landing on black is $\frac{1}{5}$.

Explain why Vlad is not correct.

The angle of the black section is too small.

[1]

- (b) The graph shows the cost of a litre of petrol for the last six months of 2017.

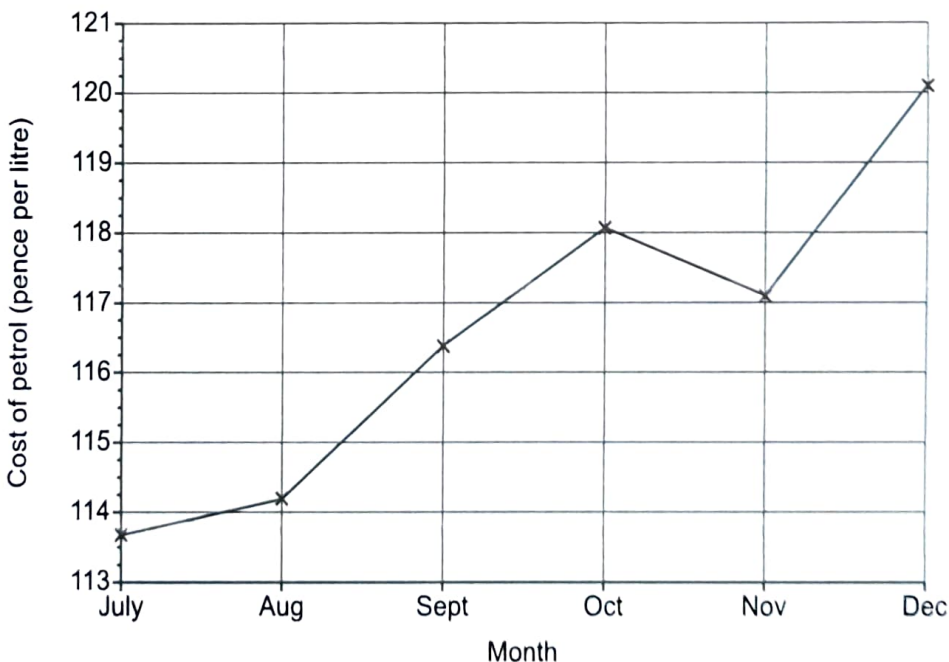

Explain why this graph is misleading.

The vertical scale does not start at 0.

[1]

4 Sophie is organising a raffle.

- Each raffle ticket costs 50p.
- She sells 400 tickets.
- The probability that a ticket, chosen at random, wins a prize is 0.1.
- Each winning ticket receives a prize worth £3.

Sophie says

I expect the raffle to make over £100 profit.

Show that Sophie is wrong.

$$400 \times 50 = 20000 \text{ p} = \pounds 200.$$

$$400 \times 0.1 \times \pounds 3 = \pounds 120$$

$$\text{Expected profit} = \pounds 200 - \pounds 120 = \pounds 80 < \pounds 100.$$

.....
..... [4]

- 5 ABC is a right-angled triangle.
AB = 20 cm and BC = 37 cm.

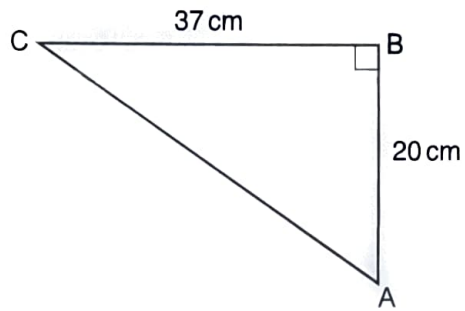

Not to scale

Calculate angle BAC.

$$\tan BAC = \frac{37}{20}$$

$$\Rightarrow BAC = \tan^{-1} \frac{37}{20}$$

..... 61.6 ° [3]

6 A bag contains some counters.

- There are 300 counters in the bag.
- There are only red, white and blue counters in the bag.
- The probability of picking a blue counter is $\frac{23}{50}$.
- The ratio of red counters to white counters is 2 : 1.

Calculate the number of red counters in the bag.

$$\frac{23}{50} \times 300 = 138 \text{ blue.}$$

$$\Rightarrow 162 \text{ red or white } (300 - 138)$$

$$\frac{2}{3} \times 162 = 108 \text{ red.}$$

..... 108

[4]

- 7 Construct the perpendicular from the point P to the line AB. Show all of your construction lines.

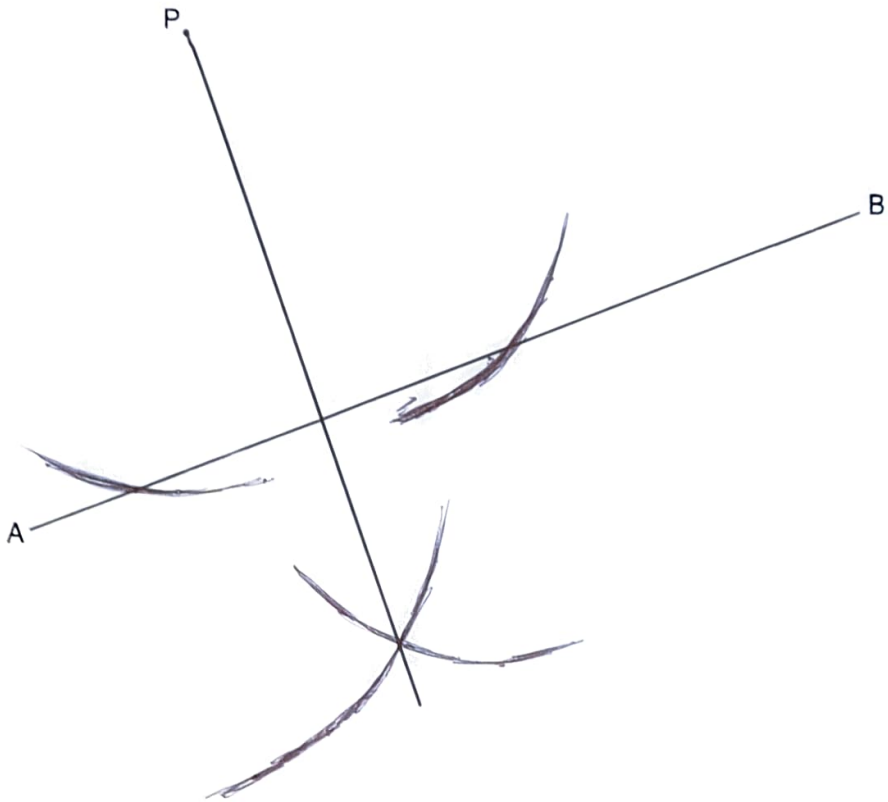

[2]

- 8 The graph shows two parallel lines, Line A and Line B.

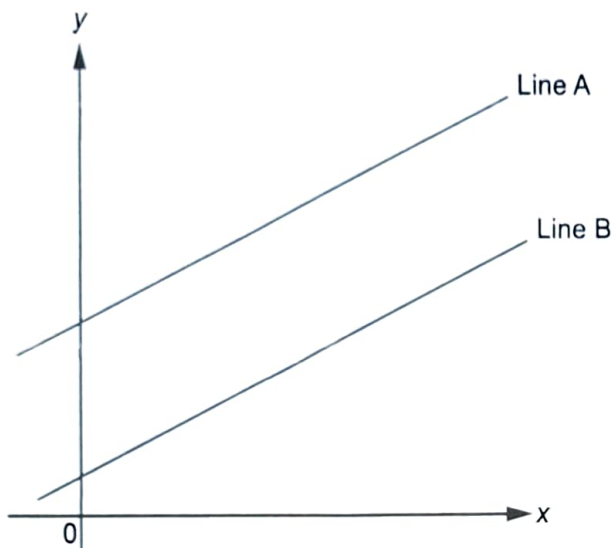

Not to scale

Line A has equation $y = 6x + 7$.

Line B passes through the point $(4, 26)$.

Find the equation of Line B.

$$m_B = 6$$

$$y - 26 = 6(x - 4) = 6x - 24$$

$$\Rightarrow y = 6x + 2$$

..... $y = 6x + 2$ [4]

- 9 Martha's solution to the inequality $8x + 5 \leq 3x - 10$ is shown on the number line.

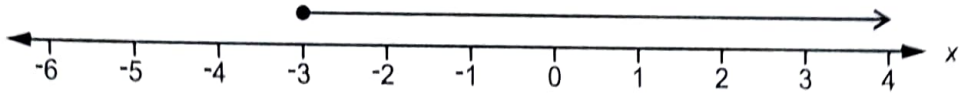

Is her solution correct?
Explain your reasoning.

$$8x + 5 \leq 3x - 10$$

$$\Rightarrow 5x \leq -15$$

$$\Rightarrow x \leq -3$$

~~✗~~

..... No, the arrow points the wrong way.

..... [4]

- 10 In 2017, the value of a house increased by 4%.
In 2018, the value of the house then decreased by 3%.

Teresa says

Over the two years the value of the house increased by exactly 1% because $4 - 3 = 1$.

Show that Teresa is wrong.

Let A be the initial price of the house.

$$2017: 1.04A.$$

$$2018: 0.97 \times 1.04A = 1.0088A$$

\Rightarrow 0.88% increase \neq 1% increase.

.....
..... [6]

11 You are given that

$$270 = 3^3 \times 2 \times 5 \quad \text{and} \quad 177147 = 3^{11}$$

- (a) (i) Find the lowest common multiple (LCM) of 270 and 177147.
Give your answer using power notation and as an ordinary number.

$$2 \times 3^{11} \times 5 = 1771470$$

- (a)(i) using power notation $2 \times 3^{11} \times 5$
as an ordinary number 1771470 [2]

- (ii) Write 177147000000 as a product of its prime factors.

$$\begin{aligned} 177147000000 &= 177147 \times 1000000 \\ &= 177147 \times 10^6 \\ &= 3^{11} \times 2^6 \times 5^6 \end{aligned}$$

- (ii) $2^6 \times 3^{11} \times 5^6$ [3]

(b) $3^n = 177147 \times 9^5$.

Find the value of n .

$$177147 = 3^{11}. \quad 9^5 = (3^2)^5 = 3^{10}.$$

$$3^{11} \times 3^{10} = 3^{21}$$

- (b) $n =$ 21 [3]

12 Antonio rolls two fair six-sided dice and calculates the **difference** between the scores. For example, if the two scores are 2 and 5 or 5 and 2 then the difference is 3.

(a) Complete the sample space diagram to show the possible outcomes from Antonio's dice.

		Dice 2					
		1	2	3	4	5	6
Dice 1	1	0	1	2	3	4	5
	2	1	0	1	2	3	4
	3	2	1	0	1	2	3
	4	3	2	1	0	1	2
	5	4	3	2	1	0	1
	6	5	4	3	2	1	0

[2]

(b) Antonio rolls the two dice three times.

Calculate the probability that he gets a difference of 1 on all three rolls. Give your answer as a fraction in its lowest terms.

$$\frac{10}{36} = \frac{5}{18}$$

$$\left(\frac{5}{18}\right)^3 = \frac{125}{5832}$$

(b) $\frac{125}{5832}$ [4]

13 Prove that the mean of any four **consecutive** even integers is an integer.

[4]

Let the cons. even integers be

$2x$, $2x+2$, $2x+4$, $2x+6$, where x is an integer

$$\frac{2x + 2x+2 + 2x+4 + 2x+6}{4} = \frac{8x+12}{4} = 2x+3,$$

which is an integer, since $2x$ and 3 are.

14 The length of the longest diagonal of a cube is 25 cm.

Calculate the total surface area of the cube.



$$\sqrt{x^2 + x^2 + x^2} = 25$$

$$\Rightarrow 3x^2 = 625.$$

$$\Rightarrow x^2 = \frac{625}{3}.$$

$$SA: 6x^2 = \frac{625}{3} \times 6 = 1250 \text{ cm}^2.$$

..... 1250 cm² [5]

15 Solve by factorisation.

$$5x^2 + 7x + 2 = 0$$

$$(5x + 2)(x + 1) = 0$$

$$x = -\frac{2}{5}, -1$$

$$x = \dots\dots\dots^{-2/5}\dots\dots\dots \text{ or } x = \dots\dots\dots-1\dots\dots\dots [3]$$

16 Sketch the graph of $y = -\sin x$ for $0^\circ \leq x \leq 360^\circ$.

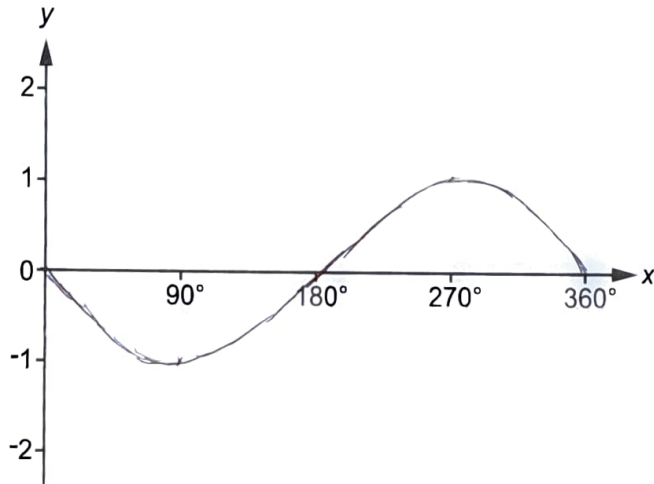

[3]

- 17 T is a radar tower.
A and B are two aircraft.

At 3pm

- aircraft A is 3250 km from T on a bearing of 015°
- aircraft B is 4960 km from T on a bearing of 057° .

Not to scale

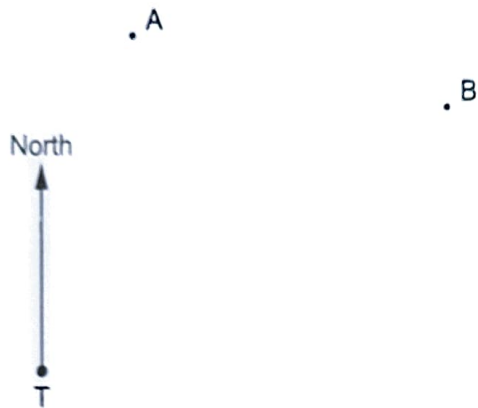

- (a) Aircraft A flies directly towards radar tower T at a speed of 890 km/h.

At what time will the aircraft pass over radar tower T?
Give your answer to the nearest minute.

$$\frac{3250 \text{ km}}{890 \text{ km/h}} = 3.65 \text{ hrs.}$$

$$3\text{pm} + 3.65 \text{ hr} =$$

(a) 6:39pm [4]

(b) Calculate the distance that was between aircraft A and aircraft B at 3pm.

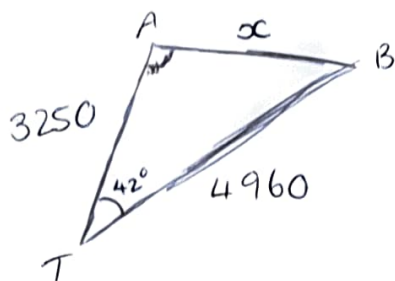

$$x^2 = 3250^2 + 4960^2 - (2 \times 3250 \times 4960 \cos 42^\circ)$$

$$= 11205110.83$$

$$\Rightarrow x = 3347.4 \text{ km}$$

(b) 3347.4 km [4]

20

- 18 A cone has radius r cm and height h cm.

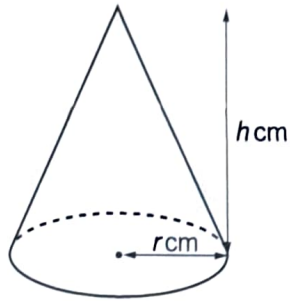

The height is three times the radius.
The volume of the cone is 2100 cm^3 .

Calculate the radius of the cone.

[The volume V of a cone with radius r and height h is $V = \frac{1}{3}\pi r^2 h$.]

$$h = 3r.$$

$$V = \frac{1}{3}\pi r^2(3r) = \pi r^3 = 2100.$$

$$\Rightarrow r^3 = \frac{2100}{\pi}$$

$$\Rightarrow r = 8.74 \text{ cm}.$$

.....8.74..... cm [4]

19 The point $(-5, 2)$ lies on the circumference of a circle, centre $(0, 0)$.

(a) Find the equation of the circle.

$$r = \sqrt{(-5)^2 + 2^2} = \sqrt{29}$$

$$\Rightarrow (x-0)^2 + (y-0)^2 = (\sqrt{29})^2 = 29.$$

$$\Rightarrow x^2 + y^2 = 29.$$

(a) $x^2 + y^2 = 29$ [4]

(b) Work out the gradient of the tangent to the circle at $(-5, 2)$.

normal: $m = \frac{0-2}{0-(-5)} = -\frac{2}{5}$

$m_1 m_2 = -1$ \Rightarrow tangent: $\frac{5}{2} = 2.5$

(b) 2.5 [2]

- 20 (a) Show that the equation $x^4 - x^2 - 9 = 0$ has a solution between $x = 1$ and $x = 2$.

[3]

$$x=1 \Rightarrow x^4 - x^2 - 9 = -9.$$

$$x=2 \Rightarrow x^4 - x^2 - 9 = 3.$$

This is a continuous function, so the change of sign indicates a root $1 < x < 2$.

- (b) Find this solution correct to 1 decimal place.
Show your working.

$$x^2 = \frac{1 \pm \sqrt{1 + 36}}{2} = \underline{-2.54}, 3.54\dots$$

$$\Rightarrow x = \sqrt{3.54\dots} = 1.882$$

$$\rightarrow 1.9$$

(b) $x = \dots\dots\dots 1.9 \dots\dots\dots$ [4]

- 21 Toy building bricks are available in two sizes, small and large. The small and large bricks are mathematically similar.

A small brick has volume 8 cm^3 and width 2.1 cm .

A large brick has volume 15.625 cm^3 .

Calculate the width of a large brick.

$$\sqrt[3]{\frac{15.625}{8}} \times 2.1 =$$

$$1.25 \times 2.1 =$$

..... 2.625 cm [4]

Turn over for question 22

- 22 At the start of 2018, the population of a town was 17 150.
At the start of 2019, the population of the town was 16 807.

It is assumed that the population of the town is given by the formula

$$P = ar^t$$

where P is the population of the town t years after the start of 2018.

- (a) Write down the value of a .

(a) 17 150 [1]

- (b) Show that $r = 0.98$.

[1]

$$17150r = 16807$$

$$\Rightarrow r = \frac{16807}{17150} = 0.98$$

- (c) Show that the population is predicted to be less than 16 000 at the start of 2022.

[2]

$$17150 \times 0.98^4 = 15818.6 < 16000.$$

- (d) Use the formula to work out what the population might have been at the start of 2017.

$$\frac{17150}{0.98} =$$

(d) 17 500 [2]

END OF QUESTION PAPER

OCR

Oxford Cambridge and RSA

Copyright Information

OCR is committed to seeking permission to reproduce all third-party content that it uses in its assessment materials. OCR has attempted to identify and contact all copyright holders whose work is used in this paper. To avoid the issue of disclosure of answer-related information to candidates, all copyright acknowledgements are reproduced in the OCR Copyright Acknowledgements Booklet. This is produced for each series of examinations and is freely available to download from our public website (www.ocr.org.uk) after the live examination series.

If OCR has unwittingly failed to correctly acknowledge or clear any third-party content in this assessment material, OCR will be happy to correct its mistake at the earliest possible opportunity.

For queries or further information please contact The OCR Copyright Team, The Triangle Building, Shaftesbury Road, Cambridge CB2 8EA.

OCR is part of the Cambridge Assessment Group; Cambridge Assessment is the brand name of University of Cambridge Local Examinations Syndicate (UCLES), which is itself a department of the University of Cambridge.