

Ma

KEY STAGE
3

TIER
4-6

2005

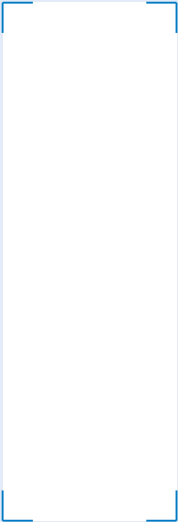

Mathematics test

Paper 2

Calculator allowed

Please read this page, but do not open your booklet until your teacher tells you to start. Write your name and the name of your school in the spaces below.

First name _____

Last name _____

School _____

Remember

- The test is 1 hour long.
- You may use a calculator for any question in this test.
- You will need: pen, pencil, rubber, ruler, angle measurer or protractor and a calculator.
- Some formulae you might need are on page 2.
- This test starts with easier questions.
- Try to answer all the questions.
- Write all your answers and working on the test paper – do not use any rough paper. Marks may be awarded for working.
- Check your work carefully.
- Ask your teacher if you are not sure what to do.

For marker's
use only

Total marks	
Borderline check	

QCA/05/1432



Instructions

Answers



This means write down your answer or show your working and write down your answer.

Calculators



You **may** use a calculator to answer any question in this test.

Formulae

You might need to use these formulae

Trapezium

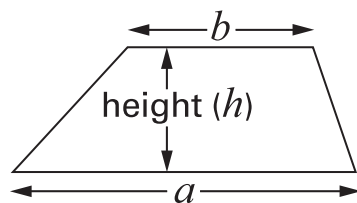

$$\text{Area} = \frac{1}{2}(a + b)h$$

Prism

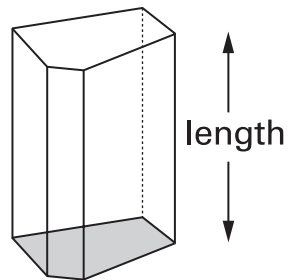

$$\text{Volume} = \text{area of cross-section} \times \text{length}$$

1. Each month **some people leave** a gym and **some people join** the gym. The diagram shows how many leave and how many join.

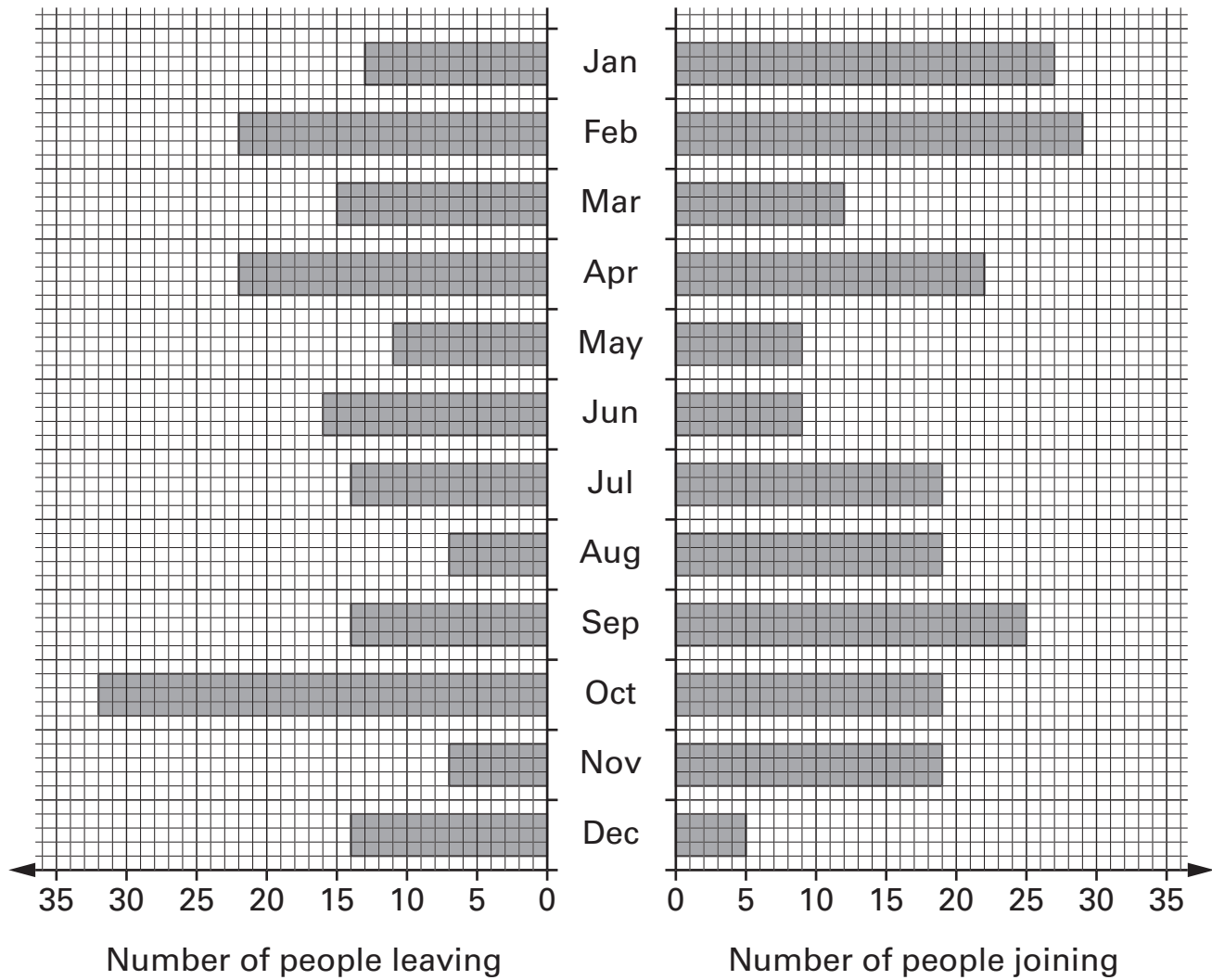

- (a) In which month did the greatest number of people **leave** the gym?



.....

1 mark

- (b) In **September**, more people joined the gym than left the gym. How many more?



.....

1 mark

2. (a) Is **3** a factor of **30**?



Yes

No

Explain how you know.



.....
1 mark

(b) I am thinking of a number that is **greater than 3**

My number is a **factor of 30**

What could my number be?

Give an example.



.....

.....
1 mark

3. Here is a sequence of shapes made with grey and white tiles.

shape number 1

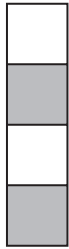

shape number 2



shape number 3

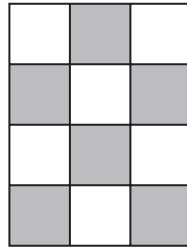

shape number 4

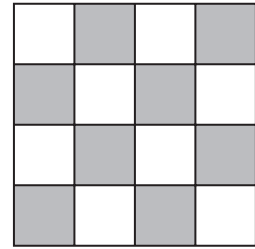

The number of grey tiles = 2 × the shape number
 The number of white tiles = 2 × the shape number

(a) Altogether, how many tiles will be in shape number 5?



..... tiles

.....
1 mark

(b) Altogether, how many tiles will be in shape number 15?



..... tiles

.....
1 mark

(c) Write the missing number below.



The **total** number of tiles = × the shape number

.....
1 mark



4. A meal in a restaurant costs the same for each person.
For **11** people the total cost is **£253**

What is the total cost for 12 people?



£

.....
.....
2 marks

5. Here is a rhombus.
The dotted lines are the **diagonals** of the rhombus.

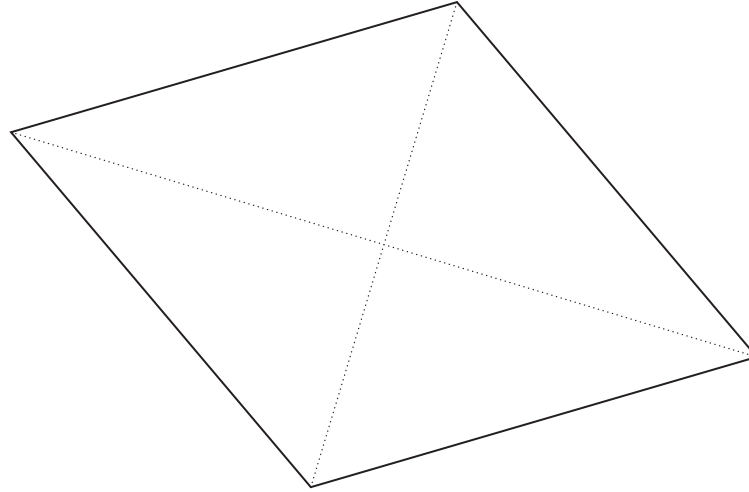

- (a) Measure **accurately** the lengths of the diagonals.

 cm

and

 cm

1 mark

- (b) To find the area of the rhombus:

Multiply the lengths of the diagonals together,
then divide the answer by 2

What is the area of the rhombus?



1 mark

1 mark

6. A survey showed these results about the number of mobile phones used in the UK.

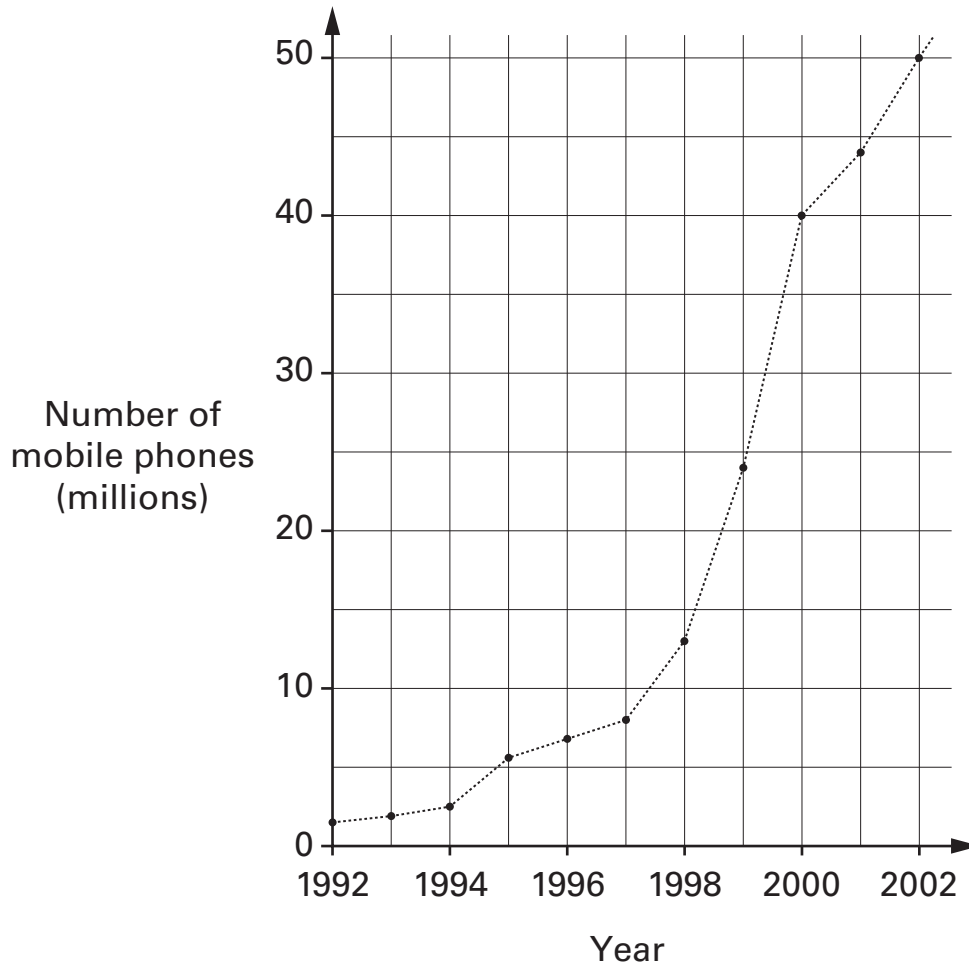

Use the graph to write the missing numbers below.



In **1992**, there were about million mobile phones.

.....
1 mark

Ten years later, there were about million mobile phones.

.....
1 mark

From **1998 to 1999**, the number of mobile phones

increased by about million.

.....
1 mark

7. Arrange **all** the numbers **1, 2, 3, 4** and **5** into two groups, so that

doubling the **sum** of the first group gives the **sum** of the second group.

There are three different ways the numbers can be arranged.

The first one is done for you.

First group

5
.....

Second group

1 2 3 4
..... / / /

First group

..... /

Second group

..... / /

First group

..... /

Second group

..... / /

.....
.....
2 marks

8. In this question, all the grids are square grids.

(a) On the grid, draw a **triangle with no right angles.**

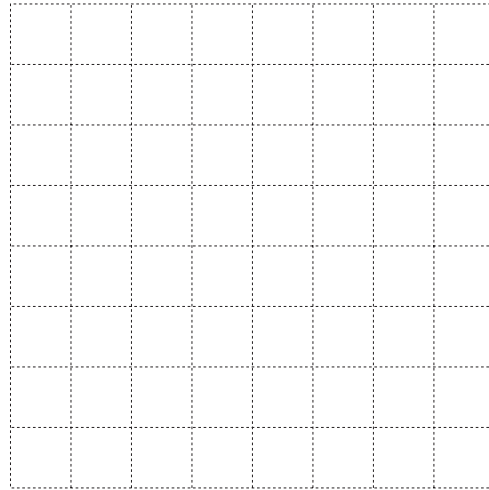

1 mark

(b) On the grid, draw a **quadrilateral with no right angles.**

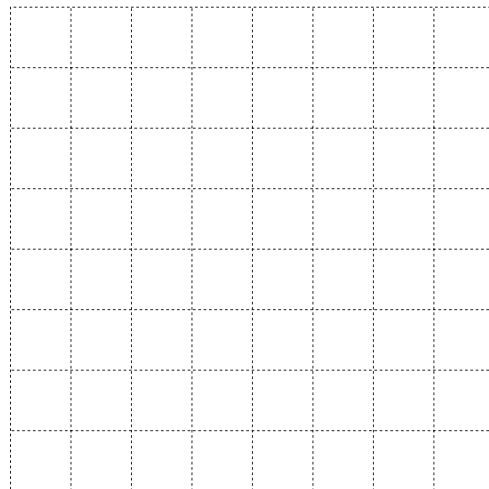

1 mark

(c) **How many right angles** does the shape on this grid have?



Number of right angles:

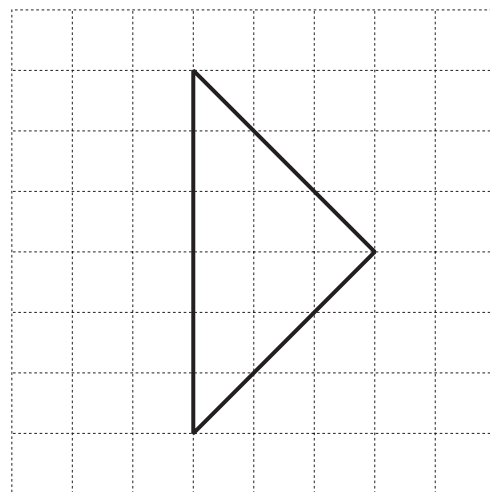

1 mark

9. Look at this algebra grid.

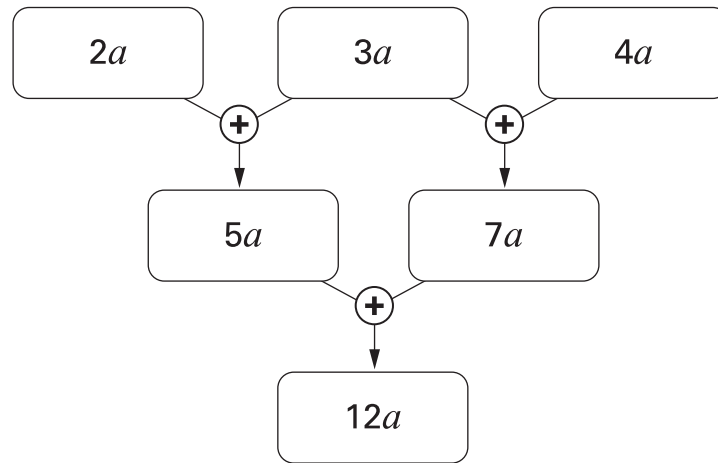

Complete the algebra grids below, simplifying each expression.

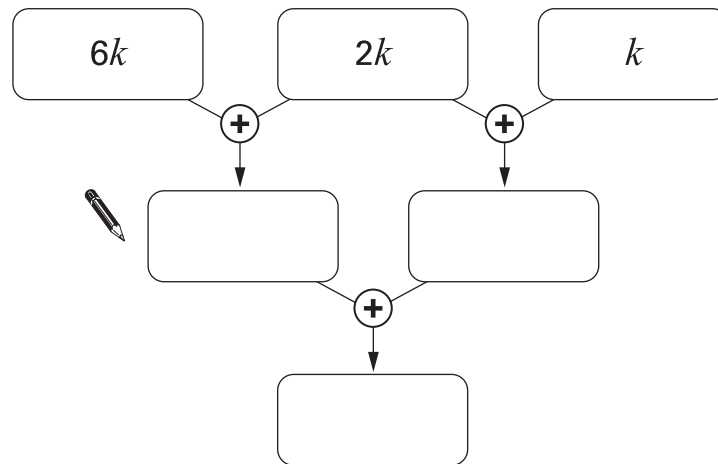

1 mark

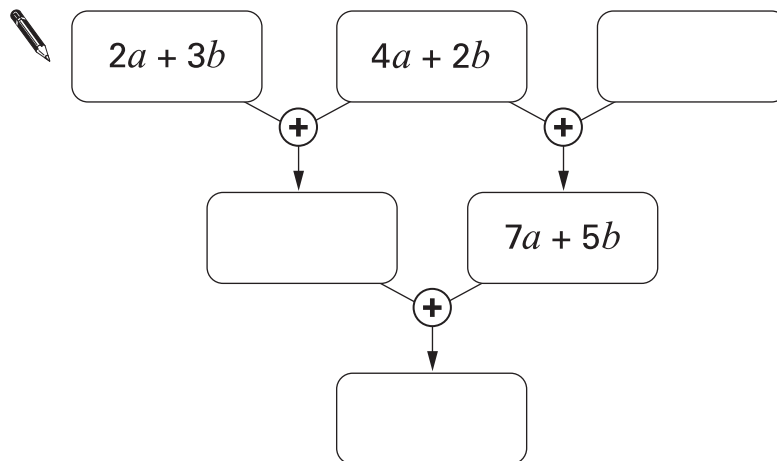

2 marks



10. Look at this information.

In 1976, a man earned £16 each week.

The pie chart shows how he spent his money.

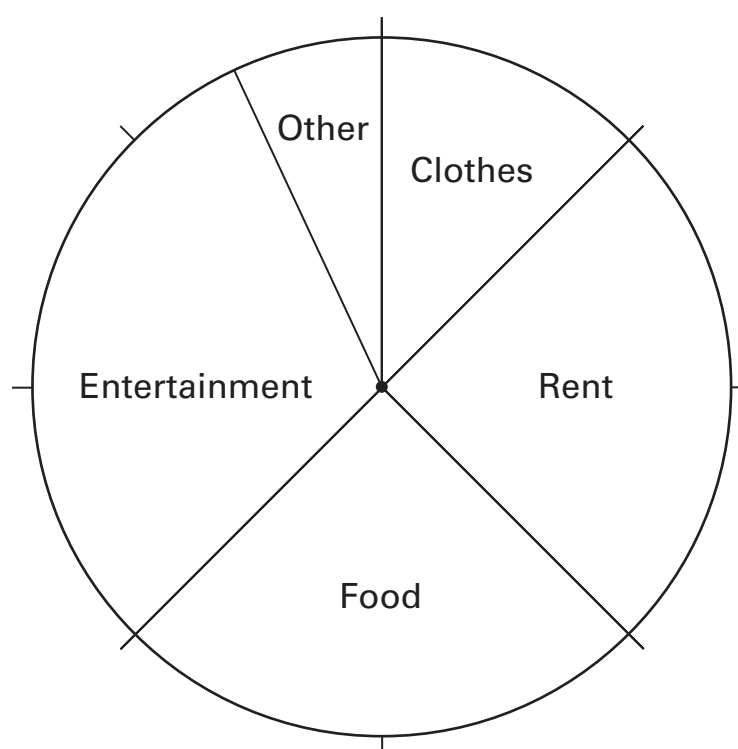

(a) How much did the man spend on **food** each week?



£

1 mark

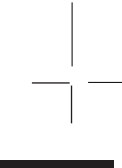
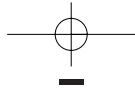

(b) Now look at this information.

In 2002, a man earned £400 each week.

The table shows how he spent his money.

Rent	£200
Food	£100
Entertainment	£50
Other	£50

Complete the pie chart below to show how the man spent his money.

Remember to **label** each sector of the pie chart.

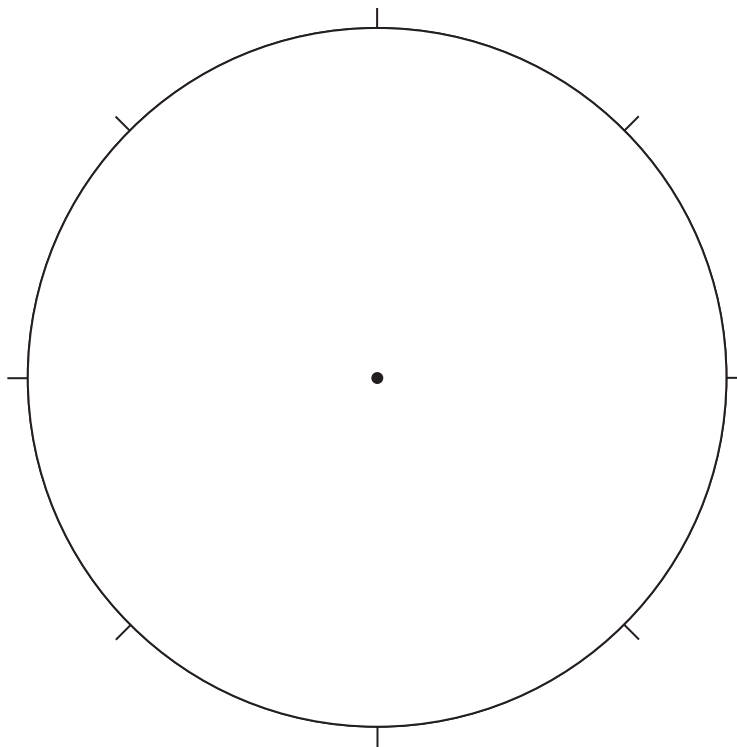

.....
.....
2 marks



11. Two shops sell packs of pens.

Supermarket
Pack of 5 pens £6.25

Village shop
Pack of 6 pens £7.20

I want to buy **30 pens**.

In which shop are the pens cheaper?

You **must** show your working.



Tick (✓) your answer.



Supermarket

Village shop

.....
.....
2 marks

12. (a) Aidan puts 2 white counters and 1 black counter in a bag.

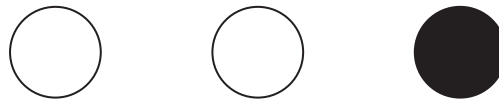

He is going to take one counter without looking.

What is the **probability** that the counter will be **black**?



.....
1 mark

(b) Aidan puts the counter back in the bag and then puts **more black** counters in the bag.

He is going to take one counter without looking.

The **probability** that the counter will be black is now $\frac{2}{3}$

How many more black counters did Aidan put in the bag?



.....

.....
1 mark

13. The scale drawing shows the positions of London and Paris.

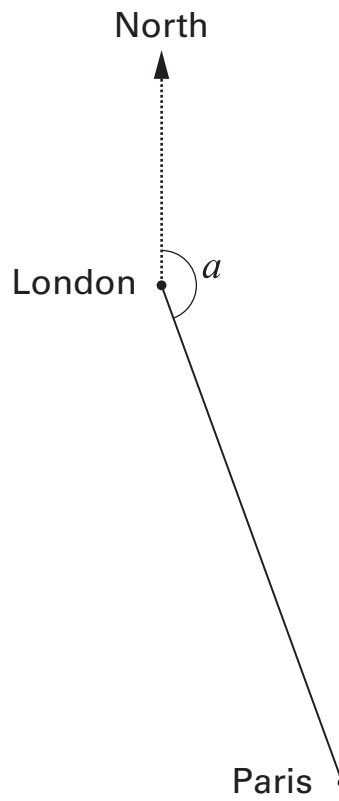

(a) From London to Paris, the angle from north is angle a

Measure accurately angle a

 $a = \dots\dots\dots^\circ$

 1 mark

(b) On the scale drawing, **1cm represents 50km.**

What is the distance, in km, from London to Paris?

 $\dots\dots\dots$ km

 1 mark

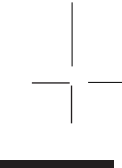
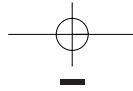

(c) A newspaper printed this information about London and Madrid.

From London to Madrid, the angle from north is **195° clockwise**.
Madrid is **1300 km** from London.

Show this information on a scale drawing.

Use the scale **1 cm represents 200 km**.

The position of London is shown for you.

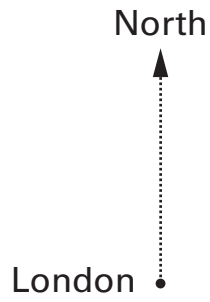

.....
.....
2 marks



14. Work out the number of boys and girls in each class below.

(a) In class 8M, there are **27 pupils**.

There are **twice as many boys** as girls.



Number of boys	Number of girls
.....

.....
1 mark

(b) In class 8K, there are **28 pupils**.

There are **two more boys** than girls.



Number of boys	Number of girls
.....

.....
1 mark

(c) In class 8T, there are **9 boys**.

The ratio of boys to girls is **1 : 2**



Number of boys	Number of girls
.....

.....
1 mark

15. Here are three lines on a centimetre square grid.
 Draw two more lines on the grid to make a **pentagon** that has
 an **area of 14cm²**

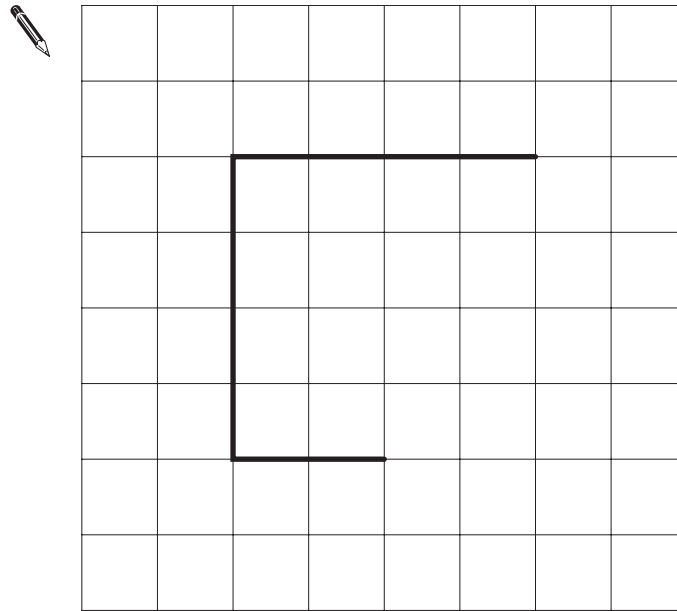

.....
1 mark

16. Use your calculator to work out the answers.

 $(48 + 57) \times (61 - 19) = \dots\dots\dots$

.....
1 mark

$$\frac{48 + 57}{61 - 19} = \dots\dots\dots$$

.....
1 mark



17. Each year, there is a tennis competition in Australia and another one in France.

The table shows how much money was paid to the winner of the men's competition in each country in 2002.

Country	Money
Australia	1 000 000 Australian dollars (£1 = 2.70 Australian dollars)
France	780 000 Euros (£1 = 1.54 Euros)

Which country paid **more** money?

You **must** show your working.



Tick (✓) the country that paid more.



Australia

France

.....
.....
2 marks

18. Look at the rectangle drawn on a square grid.

Draw an **enlargement** of this rectangle with **scale factor 2**

Use **point A** as the **centre** of enlargement.

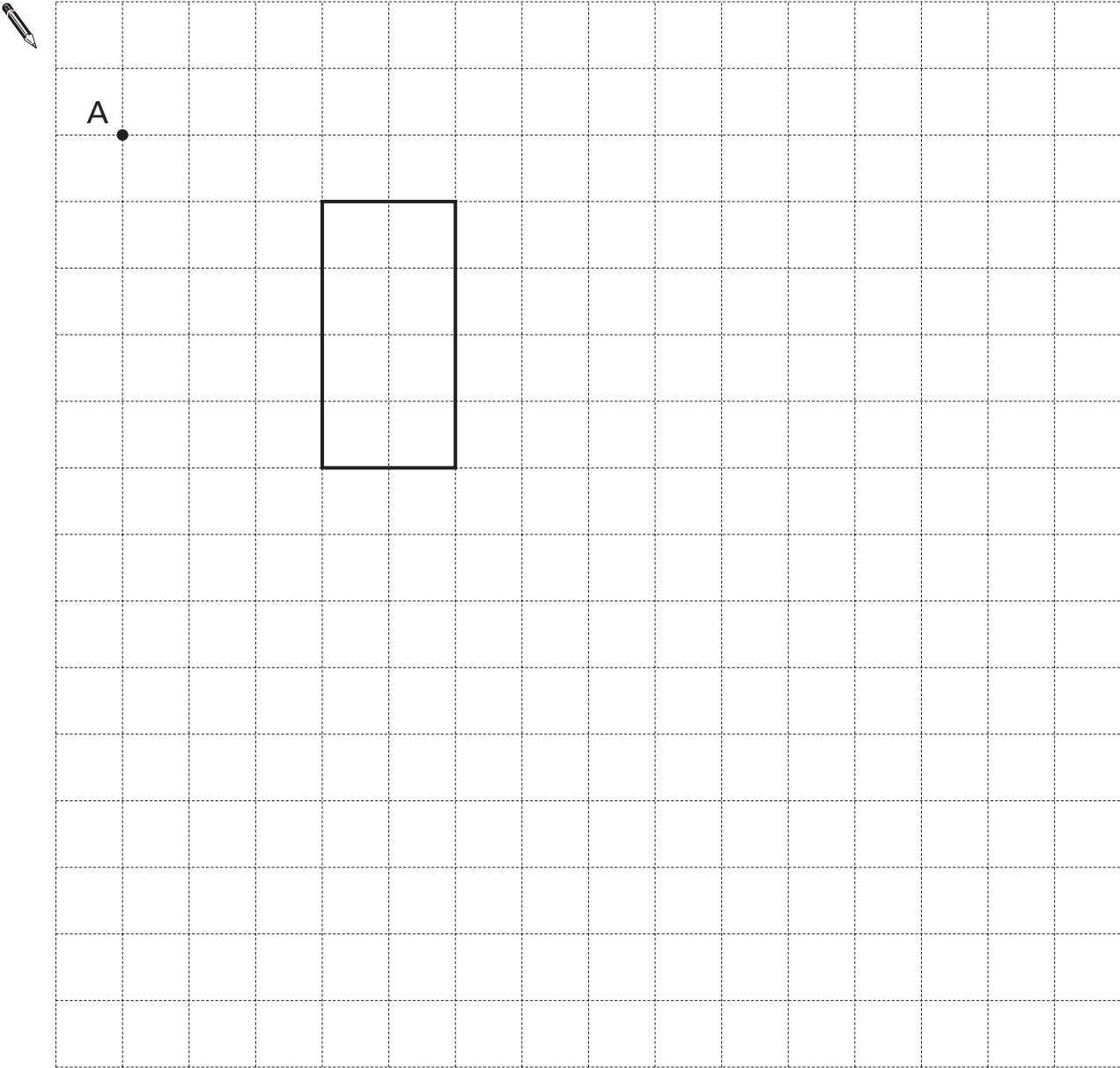

.....
.....
2 marks



19. About 2000 years ago, a Greek mathematician worked out this formula to find the area of any triangle.

For a triangle with sides a , b and c

$$\text{Area} = \sqrt{s(s-a)(s-b)(s-c)}$$

$$\text{where } s = \frac{a+b+c}{2}$$

A triangle has sides, in cm, of 3, 5 and 6

Use $a = 3$, $b = 5$ and $c = 6$ to work out the area of this triangle.



cm²

.....
.....
2 marks

20. Here is some information about all the pupils in class 9A.

	girls	boys
right-handed	13	14
left-handed	1	2

A teacher is going to choose a pupil from 9A at random.

- (a) What is the probability that the pupil chosen will be a **girl**?



1 mark

- (b) What is the probability that the pupil chosen will be **left-handed**?



1 mark

- (c) The teacher chooses the pupil at random.
She tells the class the pupil is **left-handed**.

What is the probability that this left-handed pupil is a **boy**?



1 mark

21. The screens of widescreen and standard televisions look different. They have different proportions.

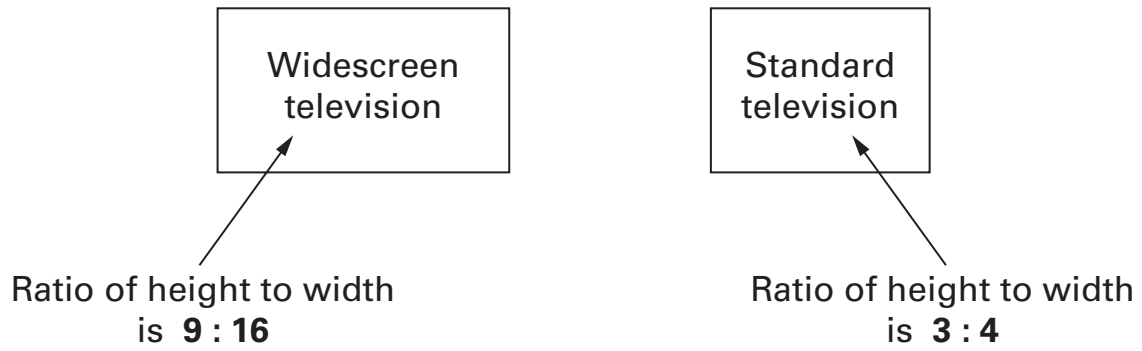

Keri starts to draw scale drawings of the televisions. For each, the height is 4.5 cm.

What should the **width** of each scale drawing be?

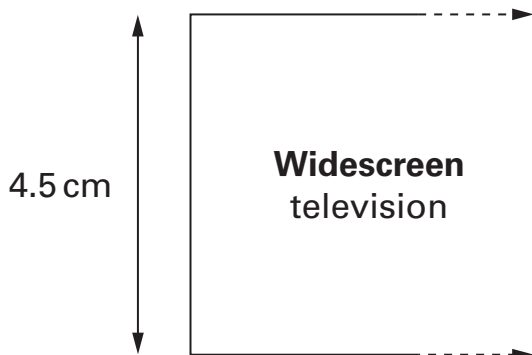

The width of this scale drawing should be cm

.....
1 mark

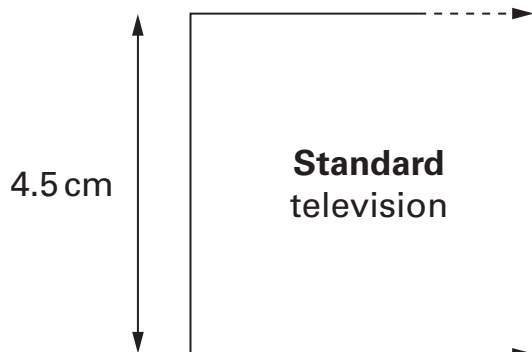

The width of this scale drawing should be cm

.....
1 mark

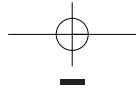

22. A spinner has the numbers 1 to 4 on it.

The probability of spinning a number 4 is 0.1

The probability of spinning a number 1 is 0.6

The probability of spinning a number 2 is the same as the probability of spinning a number 3

Calculate the probability of spinning a **number 3**



.....
.....
2 marks

23. I think of a number.

I multiply this number by **8**, then subtract **66**

The result is twice the number that I was thinking of.

What is the number I was thinking of?



.....
.....
2 marks



24. Here is some information about A levels in 2002.

	English	Mathematics
Number of students	72 000	54 000
Percentage gaining grade A	19%	37%

How many more students gained grade A in mathematics than in English?



.....
.....
2 marks

25. Look at this equation.

$14y - 51 = 187 + 4y$

Is $y = 17$ the solution to the equation?



Yes

No

Show how you know.



1 mark

26. Write these expressions as simply as possible.



$9 - 3k + 5k = \dots\dots\dots$

1 mark

$k^2 + 2k + 4k = \dots\dots\dots$

1 mark

END OF TEST